



Cover 1:  
Milo Ivory

Cover 2:  
Berlin Mink

Cover 3:  
Jester Natural

Cover 4:  
Duke Cedar

Walnut Feet

# Wyatt Collection

Colours represented are to be used as a guide only.  
Please refer to manufacturers swatch for a more accurate colour match.

Please note that colour shadings can vary slightly from each roll of fabric.  
We cannot guarantee a precise match to these samples or between cut lengths and upholstered goods.

**Extra Flex**<sup>®</sup>  
Soft, Supportive Seating

13/01/2023

# WYATT COVER GUIDE - STANDARD BACK

Please use this guide when ordering the following pieces to clarify cover options.

## STANDARD BACK

Corner Group: LH2, COR, RH2

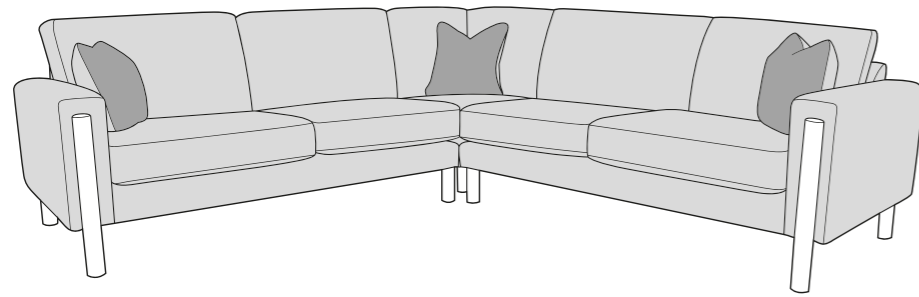

Corner Group: LH2, COR, RH1

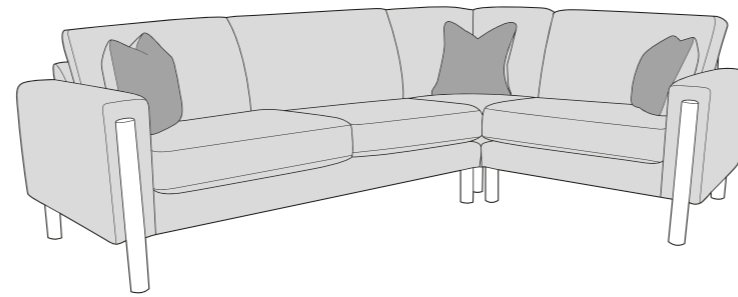

Corner Group: LH1, COR, RH2

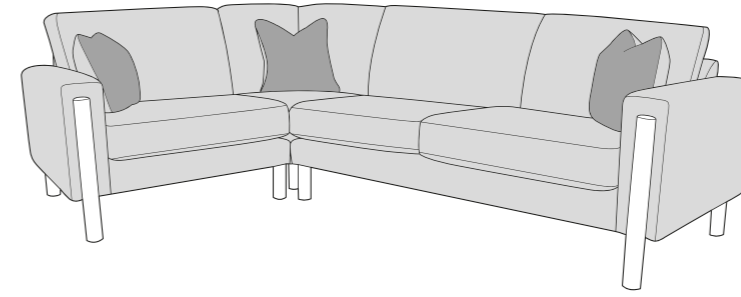

Corner Group: LH1, COR, RH1

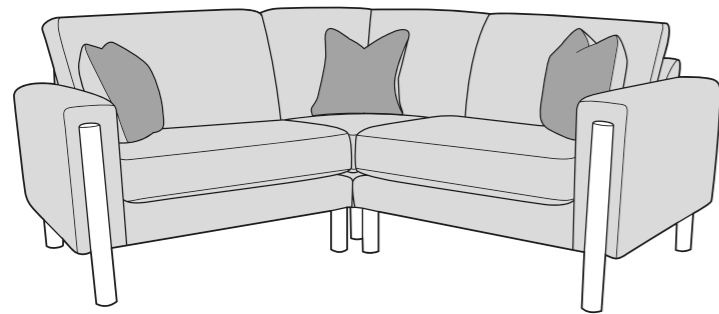

3 Seater Sofa (3ST)

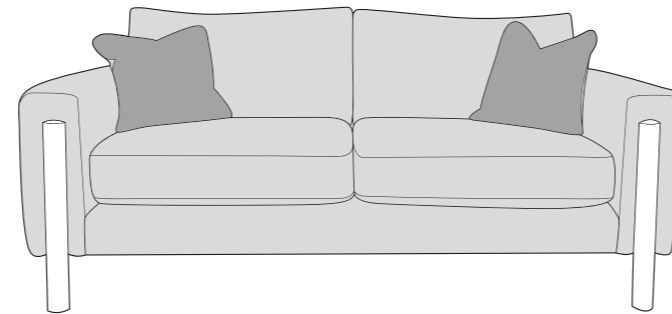

2 Seater Sofa (2ST)

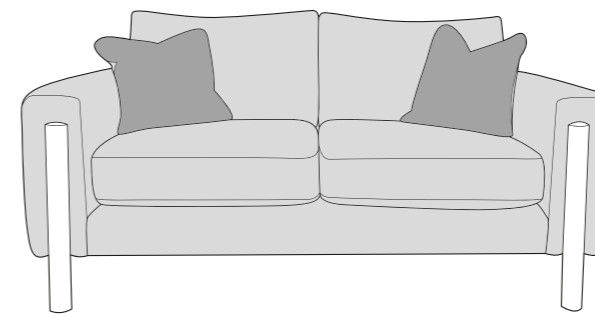

Armchair (1ST)

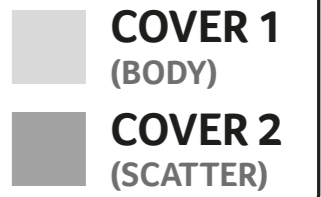
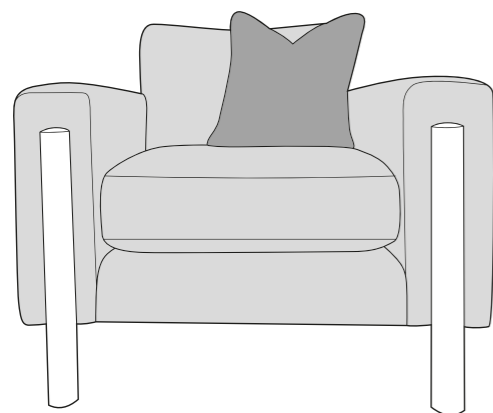

Standard Back Scatter Cushions

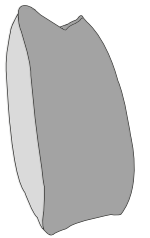

Front = Cover 2  
Back = Cover 1



APPROVED MEMBER



# WYATT COVER GUIDE - PILLOW BACK

Please use this guide when ordering the following pieces to clarify cover options.

## PILLOW BACK

Corner Group: LH2, COR, RH2

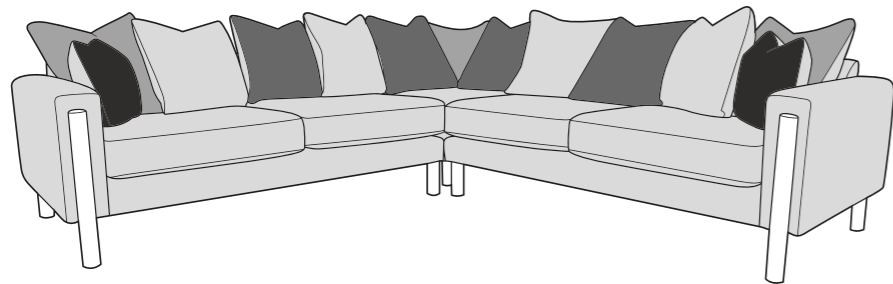

Corner Group: LH2, COR, RH1

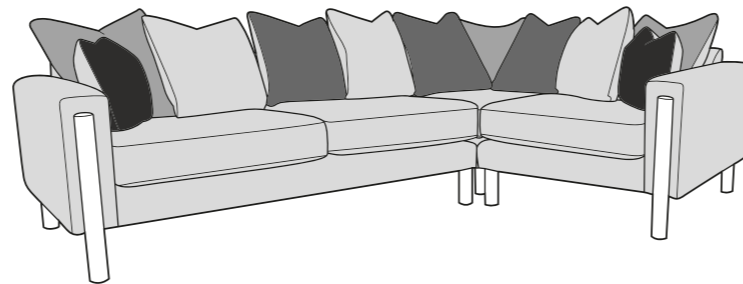

Corner Group: LH1, COR, RH2

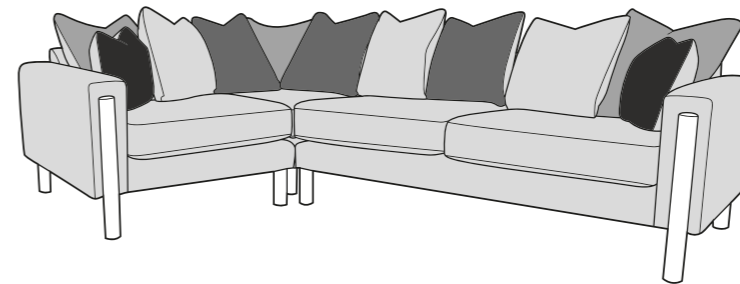

Corner Group: LH1, COR, RH1

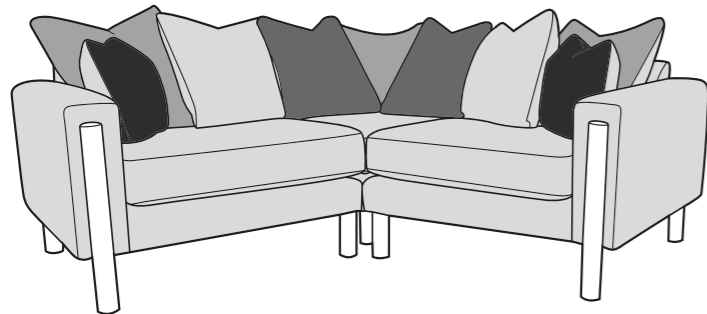

3 Seater Sofa (3ST)

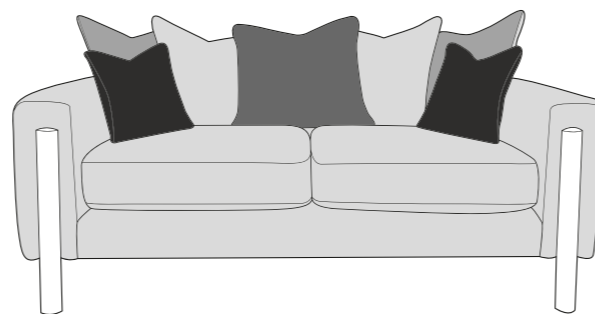

2 Seater Sofa (2ST)

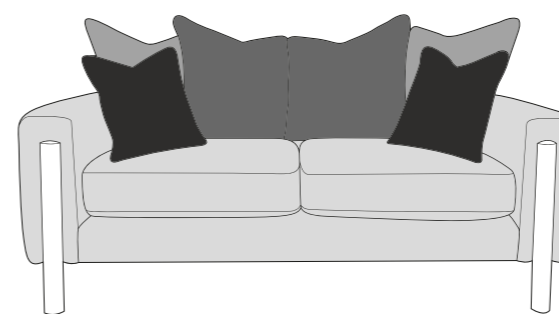

## SUGGESTED ACCENT PIECES

Wyatt Footstool (FST)

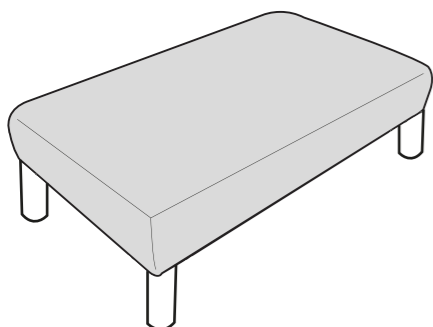

-  **COVER 1**  
(BODY)
-  **COVER 2**  
(PILLOW)
-  **COVER 3**  
(PILLOW)
-  **COVER 4**  
(SCATTER)

### Pillow Back Cushions

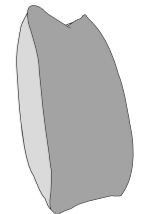

Front = Cover 2  
Back = Cover 1

### Pillow Back Scatter Cushions

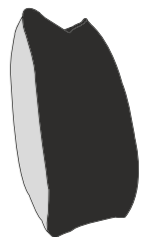

Front = Cover 4  
Back = Cover 1





# WYATT DIMENSIONS (CM)



AVAILABLE PIECES	HEIGHT 1	WIDTH 2	DEPTH 3	SEAT HEIGHT 4	SEAT DEPTH (STD) 5	SEAT DEPTH (PIL) 5	SEAT WIDTH 6	ACCESS DIAGONAL 7	OUTBACK HEIGHT 8	ARM HEIGHT 9	WEIGHT (KG)	PILLOW BACK NUMBER	SCATTER CUSHIONS
LH2, COR, RH2 CORNER GROUP	97	279	279	50	59	52	N/A	N/A	72	66	133	11 (x4 cover 1/x3 cover 2/x4 cover 3)	2 (PIL Back) 3 (STD Back)
LH2, COR, RH1 CORNER GROUP or LH1, COR, RH2 CORNER GROUP	97	279	193	50	59	52	N/A	N/A	72	66	114.5	9 (x3 cover 1/ x3 cover 2/x3 cover 3)	2 (PIL Back) 3 (STD Back)
LH1, COR, RH1 CORNER GROUP	97	193	193	50	59	52	N/A	N/A	72	66	93	7 (x2 cover 1/ x3 cover 2/ x2 cover 3)	2 (PIL Back) 3 (STD Back)
LH2/RH2 UNIT	97	182	97	50	59	52	165	202	72	66	51.5	4 (x2 cover 1/x1 cover 2/x1 cover 3)	1
LH1/RH1 UNIT	97	96	97	50	59	52	79	137	72	66	33	2 (x1 cover 1/x1 cover 3)	1
CORNER UNIT (COR)	97	97	97	50	59	52	N/A	128	72	66	30	3 ( x1 cover 2/x2 cover 3)	1 (STD Back)
3 SEATER SOFA (3ST)	97	197	97	50	59	52	154	220	72	66	58	5 (x2 cover 1/ x2 cover 1/x1 cover 3)	2
2 SEATER SOFA (2ST)	97	169	97	50	59	52	132	192	72	66	50	4 (x2 cover 2/x2 cover 3)	2
ARMCHAIR (1ST)	97	96	97	50	59	52	59	133	72	66	36.5	N/A	1
<b>ACCENT PIECES</b>													
WYATT FOOTSTOOL (FST)	33	102	62	N/A	N/A	N/A	N/A	N/A	N/A	N/A	14.5	N/A	N/A

\* Hardwood & composite board frame.

\* Dowelled, screwed, glued & stapled joinery.

\* Black, Walnut, Mid Oak & Grey Ash foot options.

\* ExtraFlex high comfort seat cushions.

\* Available with standard & pillow back option.

\* Feather filled scatters included. 

\* Fibre filled backs for added comfort.

\* Serpentine seat springs & silent wire.

\* Elasticated back webbing.

## DIMENSION GUIDE

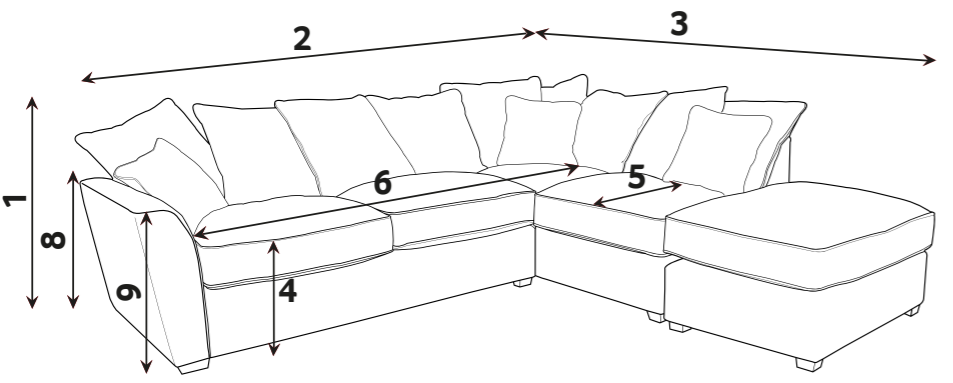

Check the diagonal access dimension to ensure furniture will fit in your home.

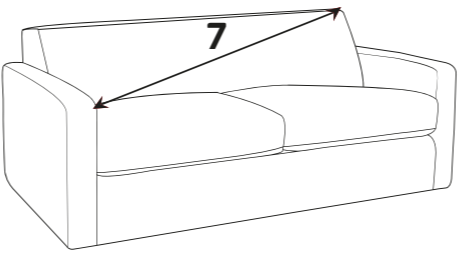

- 1 - HEIGHT
- 2 - WIDTH
- 3 - DEPTH
- 4 - SEAT HEIGHT
- 5 - SEAT DEPTH (STD & PILLOW)
- 6 - SEAT WIDTH
- 7 - DIAGONAL ACCESS
- 8 - OUTBACK HEIGHT
- 9 - ARM HEIGHT

Illustrations used for reference only.

Please note : All dimension are approximate. Allow tolerance of +/- 2.5cm.

## Extra Flex®

A high density foam base seat interior with a hand-rolled carded fibre, channelled topper which provides both softness and support.

## CARE GUIDE

Extraflex seat cushions should be plumped up on a regular basis to help maintain the aesthetic appeal of your upholstery, the plumping of cushions is essential to help retain the comfort and softness of any piece of upholstered furniture.

To improve the longevity of your hand-made furniture, we recommend rotating cushions (where applicable).

For further information on maintaining your furniture please refer to the care guide located under the seat platform.

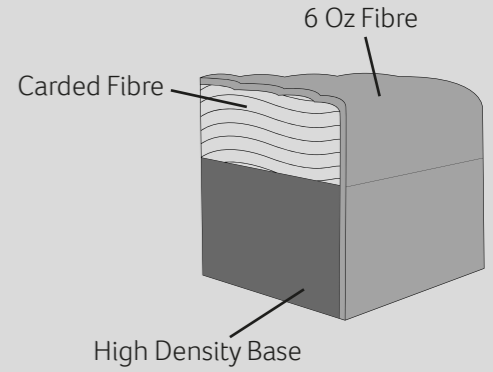

## FOOT OPTIONS:



Wood is a natural product and will vary in shade/colour from item to item. Feet may require fitting.

