



Cover 4:
Valencia Spot Natural

Cover 3:
Festival Ocean

Cover 2:
Valencia Zig Zag Natural

Cover 1:
Aaron Truffle

Antique Wood Feet

Phoenix Collection

Colours represented are to be used as a guide only.
Please refer to manufacturers swatch for a more accurate colour match.

Please note that colour shadings can vary slightly from each roll of fabric.
We cannot guarantee a precise match to these samples or between cut lengths and upholstered goods.

Extra Flex[®]
Soft, Supportive Seating

12/04/2024

PHOENIX COVER GUIDE: STANDARD BACK

Please use this guide when ordering the following pieces to clarify cover options.

LH2, RFC, FST (L2, RFC, P) Group

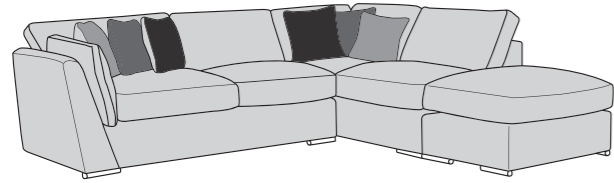

FST, LFC, RH2 (P, LFC, R2) Group

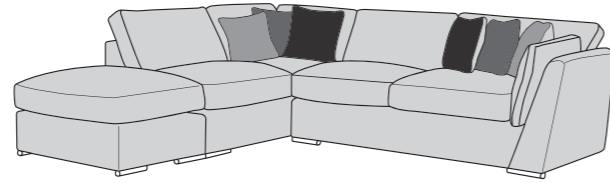

L2S, RFC, FST (L2S, RFC, P) Group

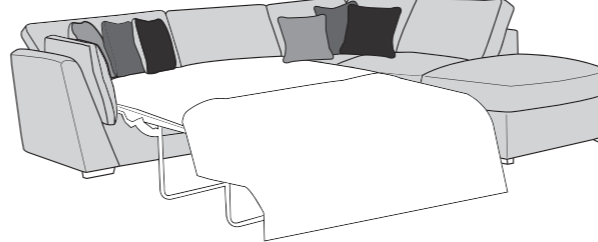

FST, LFC, R2S (P, LFC, R2S) Group

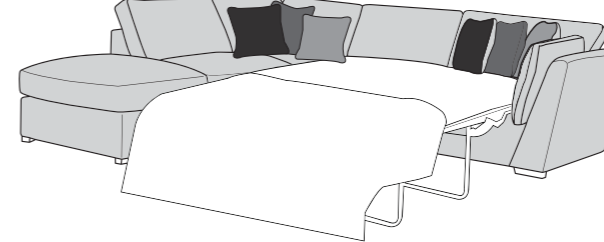

LH2, COR, RH1 (L2, CO, R1) Group

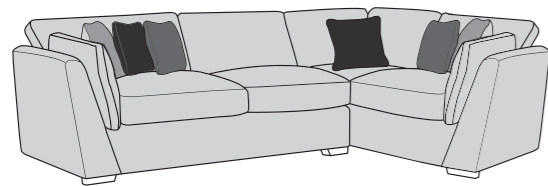

LH1, COR, RH2 (L1, CO, R2) Group

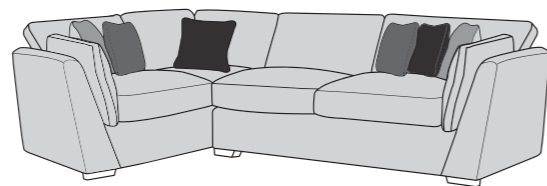

L2S, COR, RH1 (L2S, CO, R1) Group

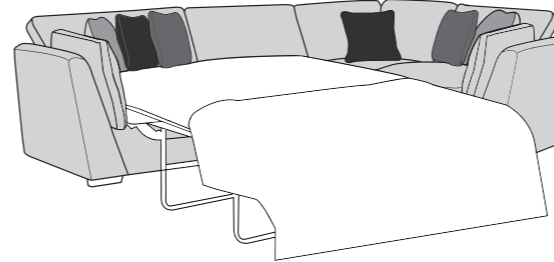

LH1, COR, R2S (L1, CO, R2S) Group

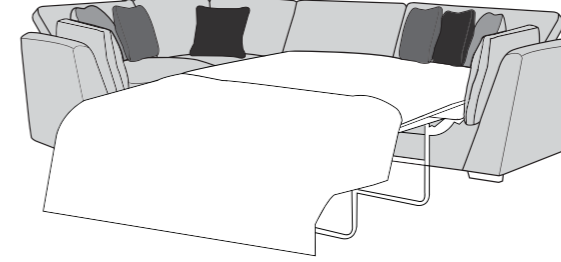

LH1, COR, RH1 (L1, CO, R1) Group

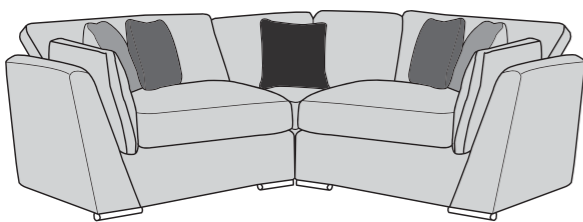

LH2, COR, RH2 (L2, CO, R2) Group

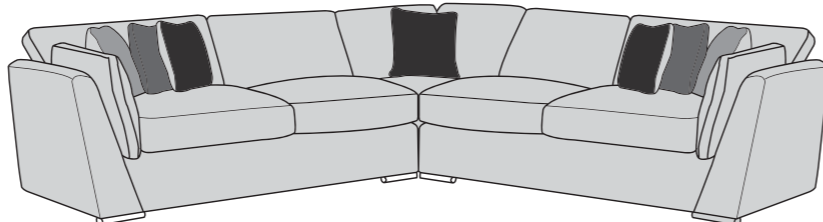

ALU (AU)

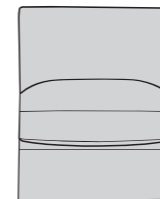

3 Seater Sofa (3ST)

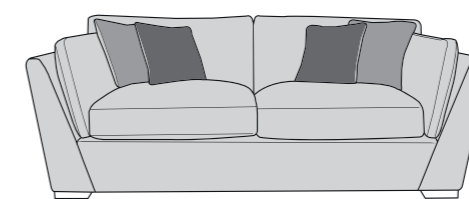

2 Seater Sofa (2ST)

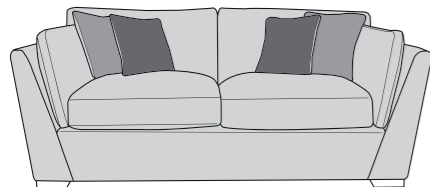

Love Chair (LOV)

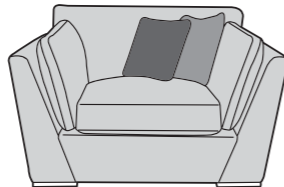



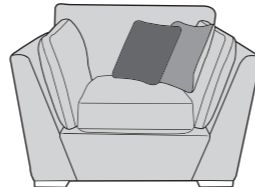

Arm Chair (1ST)

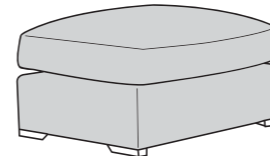

Footstool P (FST)



-  **COVER 1**
(BODY)
-  **COVER 2**
(SCATTER)
-  **COVER 3**
(SCATTER)
-  **COVER 4**
(SCATTER)

Scatter Cushions

Scatter Cover 2

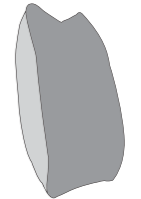

Front = Cover 2
Back = Cover 1

Scatter Cover 3

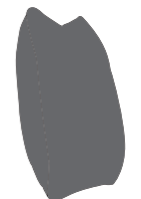

Front = Cover 3
Back = Cover 3

Scatter Cover 4

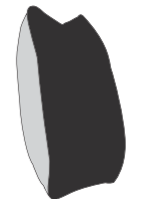

Front = Cover 4
Back = Cover 1

ACCENT PIECES

Storage Footstool (FSS)

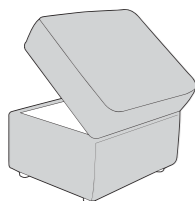

PHOENIX DIMENSIONS (CM)

AVAILABLE PIECES	HEIGHT 1	WIDTH 2	DEPTH 3	SEAT HEIGHT 4	SEAT DEPTH 5	SEAT WIDTH 6	ACCESS DIAGONAL 7	OUTBACK HEIGHT 8	ARM HEIGHT 9	WEIGHT (KG)	SCATTER CUSHION NO.
LH2, RFC, FST or RH2, LFC, FST CORNER GROUP	87	293	250	54	60	N/A	N/A	69	69	122	6
L2S, RFC, FST or R2S, LFC, FST CORNER GROUP	87	258	250	54	60	N/A	N/A	69	69	132	6
LH2, COR, RH1 or LH1, COR, RH2 CORNER GROUP	87	293	208	54	60	N/A	N/A	69	69	118	6
L2S, COR, RH1 or R2S, COR, LH1 CORNER GROUP	87	258	208	54	64	N/A	N/A	69	69	128	6
LH1, COR, RH1 CORNER GROUP	87	208	208	54	60	N/A	N/A	69	69	100	5
LH2, COR, RH2 CORNER GROUP	87	293	293	54	60	N/A	N/A	69	69	136	7
ALU - ARMLESS UNIT	87	82	95	54	60	82	123	69	N/A	25	N/A
COR - CORNER UNIT	87	95	95	54	60	N/A	131	69	N/A	32	1
FST - LARGE FOOTSTOOL UNIT	53	74	95	54	60	N/A	112	N/A	N/A	19	N/A
LH1/RH1 UNIT	87	113	95	54	60	81	143	69	69	34	2
LH2/RH2 UNIT	87	198	95	54	60	160	206	69	69	52	3
LFC/RFC UNIT	87	176	95	54	60	138	193	69	69	51	3
L2S/R2S - BED ACTION	87	163	95	54	60	136	191	69	69	62	3
3 SEATER SOFA (3ST)											
87 224 95 54 60 156 237 69 69 62 4											
2 SEATER SOFA (2ST)											
87 196 95 54 60 129 211 69 69 58 4											
LOVE CHAIR (LOV)											
87 144 95 54 60 79 160 69 69 45.5 2											
ARM CHAIR (1ST)											
87 122 95 54 60 54 148 69 69 43 2											
ACCENT PIECES											
STORAGE FOOTSTOOL (FSS)											
45 63 50 N/A N/A N/A 75 N/A N/A 12.5 N/A											

- * Hardwood & composite board frame.
- * Dowelled, screwed, glued & stapled joinery.
- * Chrome & Wood foot options.

- * ExtraFlex high comfort seat cushions.
- * Fibre filled backs for added comfort.
- * Fibre filled scatters included.

- * Serpentine seat springs & silent wire.
- * Elasticated back webbing.

SOFABEDS: SLEEP OPTIONS

STANDARD ACTION & FOAM MATTRESS

A three fold metal action with a sprung 'polyprop' base. Complemented by a high performance foam mattress. For occasional use only.

Mattress Thickness: 6cm

Mattress Length: 185cm

3 fold action 140Kg total max occupancy weight

120cm sofa bed:

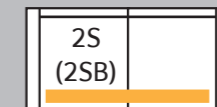

Mattress Width: 113cm



DIMENSION GUIDE

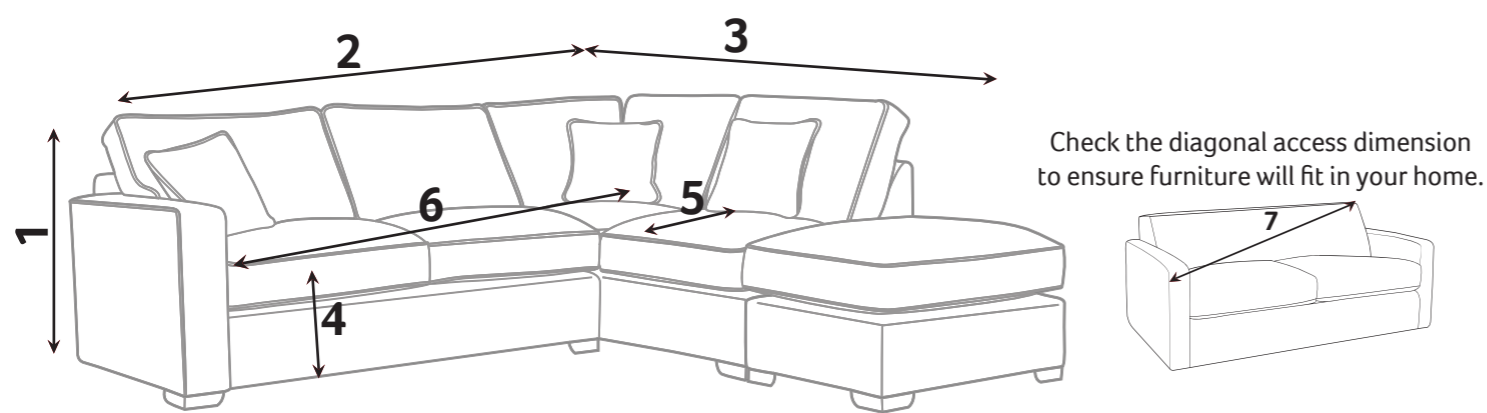

- 1 - HEIGHT
- 2 - WIDTH
- 3 - DEPTH
- 4 - SEAT HEIGHT
- 5 - SEAT DEPTH (STD & PILLOW)
- 6 - SEAT WIDTH
- 7 - DIAGONAL ACCESS

Illustrations used for reference only.

Extra Flex®

A high density foam base seat interior with a hand-rolled carded fibre, channelled topper which provides both softness and support.

CARE GUIDE

Extraflex seat cushions should be plumped up on a regular basis to help maintain the aesthetical appeal of your upholstery, the plumping of cushions is essential to help retain the comfort and softness of any piece of upholstered furniture.

To improve the longevity of your hand-made furniture, we recommend rotating cushions (where applicable).

For further information on maintaining your furniture please refer to the care guide located under the seat platform.

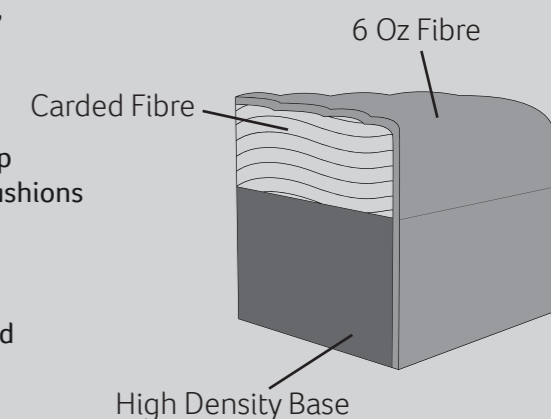

- FOOT OPTIONS:**
- Oak (Light)
 - Mid Oak
 - Antique (Dark)
 - Chrome

Wood is a natural product and will vary in shade/colour from item to item.