



Cover 2:
Flash Spa

Cover 1:
Ramsay Spa

Cover 1:
Flash Spa

Carnival Footstool

Mid Oak Feet

Kennedy Collection

Colours represented are to be used as a guide only.
Please refer to manufacturers swatch for a more accurate colour match.

Please note that colour shadings can vary slightly from each roll of fabric.
We cannot guarantee a precise match to these samples or between cut lengths and upholstered goods.

foamflex™

Award Winning Seating Technology

19/01/2021

KENNEDY COVER GUIDE: STANDARD BACK ONLY

Please use this guide when ordering the following pieces to clarify cover options.

Corner Group: LH2, COR, RH1 (L2, CO, R1)

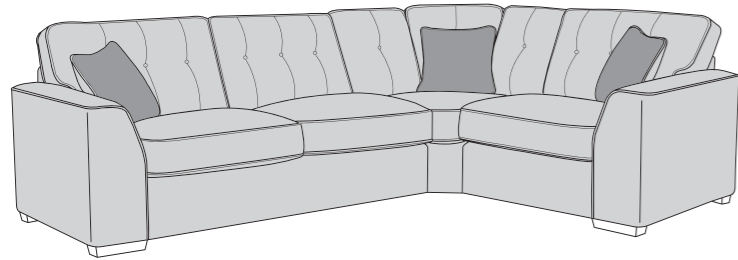

Corner Group: LH1, COR, RH2 (L1, CO, R2)

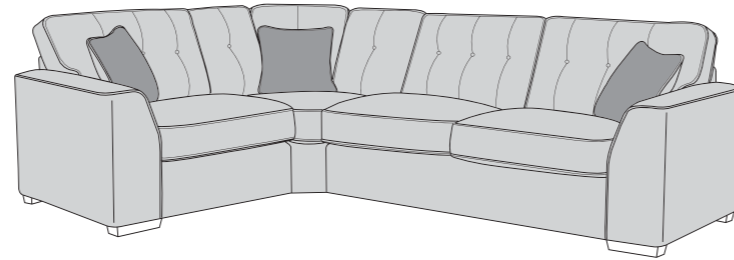

Corner Group: LH2, COR, RH2 (L2, CO, R2)

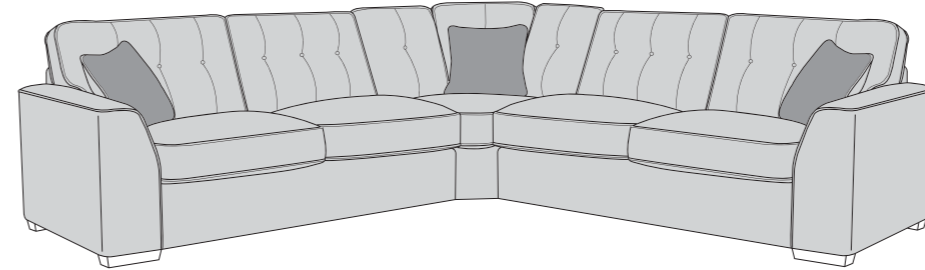

Corner Group: LH1, COR, RH1 (L1, CO, R1)

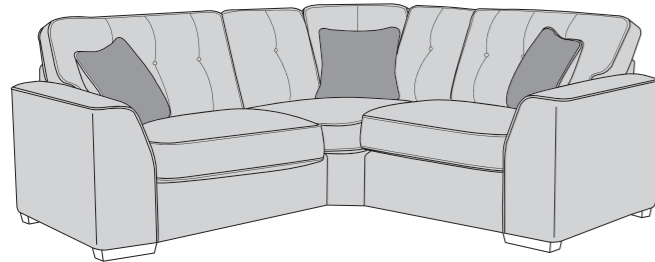

ALU (AU) : Armless unit

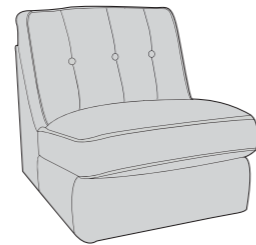

3 Seater Sofa (3ST)

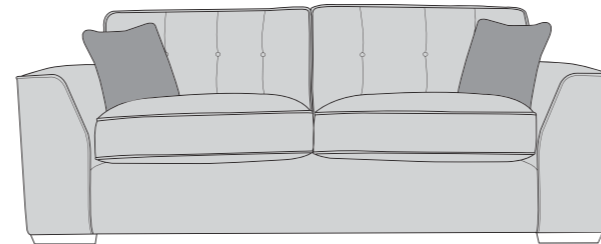

2 Seater Sofa (2ST)

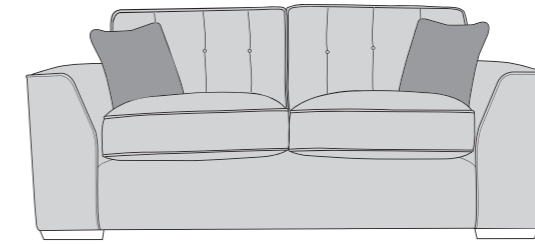

Arm Chair (1ST)

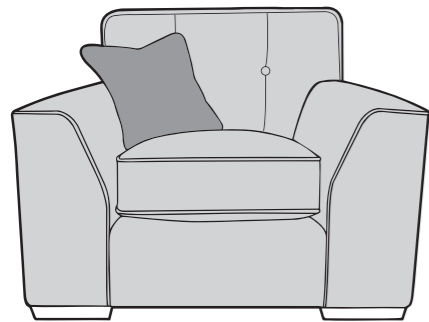

2 Seater Sofa Bed (2SB)

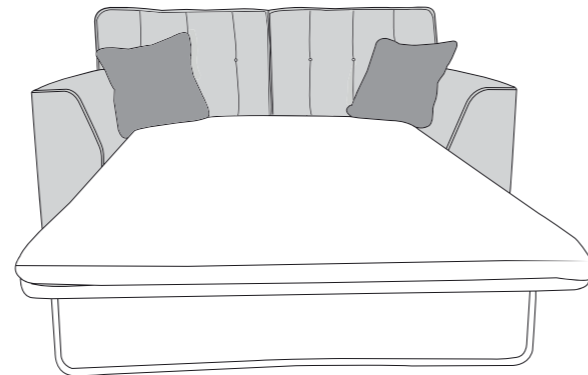

ACCENT PIECES

York Accent Chair (ACH)

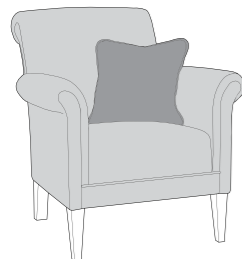

Storage Footstool F (FSS)

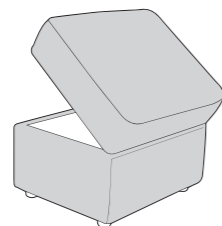

Carnival Footstool (FST)

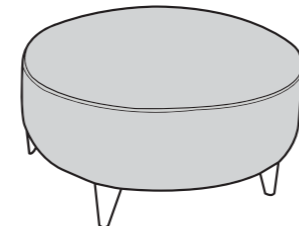

 **COVER 1**
(BODY)

 **COVER 2**
(SCATTER)

Standard Back Scatter Cushions

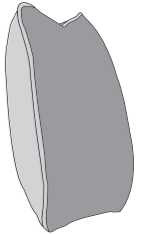

Front = Cover 2
Piping = Cover1
Back = Cover1

KENNEDY DIMENSIONS (CM)

AVAILABLE PIECES	HEIGHT 1	WIDTH 2	DEPTH 3	SEAT HEIGHT 4	SEAT DEPTH 5	SEAT WIDTH 6	ACCESS DIAGONAL 7	WEIGHT (KG)	SCATTER CUSHION NO.
LH2, COR, RH1 GROUP or LH1, COR, RH2 GROUP	87	293	212	54	58	N/A	N/A	120	3
LH2, COR, RH2 GROUP	87	293	293	54	58	N/A	N/A	146.5	3
LH1, COR, RH1 GROUP	87	212	212	54	58	N/A	N/A	110.5	3
LH2/RH2 UNIT	87	187	98	54	58	162	206	55	1
LH1/RH1 UNIT	87	106	98	54	58	79	136	37	1
ALU - ARMLESS UNIT	87	81	98	54	58	81	124	24	N/A
COR - CORNER UNIT	87	106	106	54	66	66	148	36.5	1
SOFA BEDS									
3 SEATER SOFA (3ST)	87	216	98	54	58	167	223	68	2
2 SEATER SOFA (2ST)	87	188	98	54	58	140	200	60.5	2
ARM CHAIR (1ST)	87	114	98	54	58	60	137	48.5	1
SOFA BEDS									
2SB - 120CM STANDARD SOFA BED	87	188	98	54	59	140	161	77	2
OPEN DEPTH OF SOFA BEDS 226CM									
ACCENT PIECES									
YORK ACCENT CHAIR (ACH)	85	76	81	445	50	48	N/A	19.5	N/A
STORAGE FOOTSTOOL (FSS)	43	61	50	N/A	N/A	N/A	75	12.5	N/A
CARNIVAL FOOTSTOOL (FST)	42	79	79	N/A	N/A	N/A	79	13	N/A

* Hardwood & composite board frame.

* Dowelled, screwed, glued & stapled joinery.

* Light & Dark Wood foot options.

* Fibre filled backs for added comfort.

* Fibre filled scatters included.

* Award winning foamflex seat interior with 5 year guarantee.

* Serpentine seat springs & silent wire.

* Elasticated back webbing.

SOFABEDS: SLEEP OPTIONS

STANDARD ACTION & FOAM MATTRESS

A three fold metal action with a sprung 'polyprop' base. Complemented by a high performance foam mattress. For occasional use only.

Mattress Thickness: 6cm

Mattress Length: 185cm

3 fold action is 140Kg total max occupancy weight



120cm sofa bed:

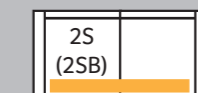

Mattress Width: 113cm



DIMENSION GUIDE

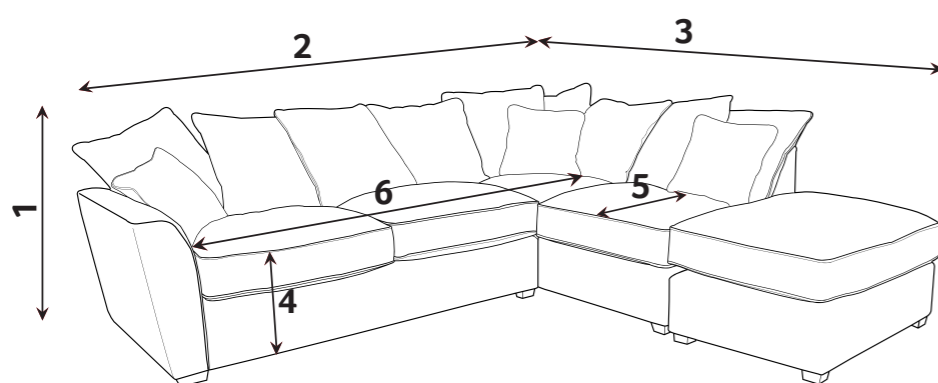

1 - HEIGHT
2 - WIDTH

3 - DEPTH
4 - SEAT HEIGHT

5 - SEAT DEPTH (STD & PILLOW)
6 - SEAT WIDTH

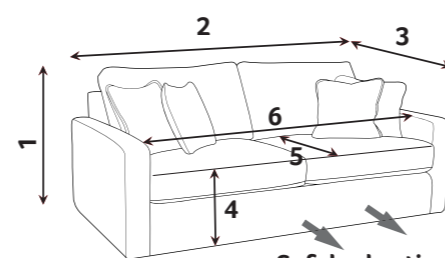

Sofabed action

Check the diagonal access dimension to ensure furniture will fit in your home.

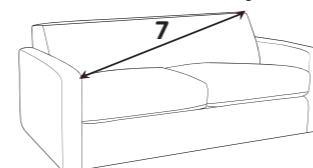

7 - DIAGONAL ACCESS

Illustrations used for reference only.

foamflex

Our new expertly engineered foam seat interior gives you the comfort of fibre with the retention of foam. Our foamflex seat interiors have been granted the FIRA GOLD Award, a mark of quality under-pinning all necessary testing of the product materials, design and production techniques.

CARE GUIDE

To improve the longevity of your hand-made furniture, we recommend rotating cushions (where applicable).

For further information on maintaining your furniture, please refer to the Care Guide located under the seat platform.



Our foamflex seat interiors have been granted the FIRA GOLD Award, a mark of quality under-pinning all necessary testing of the product materials, design and production techniques.

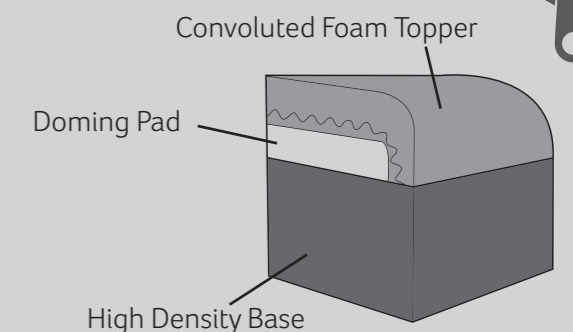

Mid Oak (Light)

Antique (dark)

FOOT OPTIONS:



Please note: All dimension are approximate. Allow tolerance of +/- 2.5cm.

Wood is a natural product and will vary in shade/colour from item to item. Feet may require fitting.



19/01/2021