



Cover 1:
Watson Taupe

Cover 2 (Piping):
Eden Carbon

Antique Feet

Finley Collection

Colours represented are to be used as a guide only.
Please refer to manufacturers swatch for a more accurate colour match.

Please note that colour shadings can vary slightly from each roll of fabric.
We cannot guarantee a precise match to these samples or between cut lengths and upholstered goods.

foamflex™

Award Winning Seating Technology

16/02/2022

FINLEY COVER GUIDE - STANDARD BACK

Please use this guide when ordering the following pieces to clarify cover options.

STANDARD BACK

4 Seater Sofa (4ST)

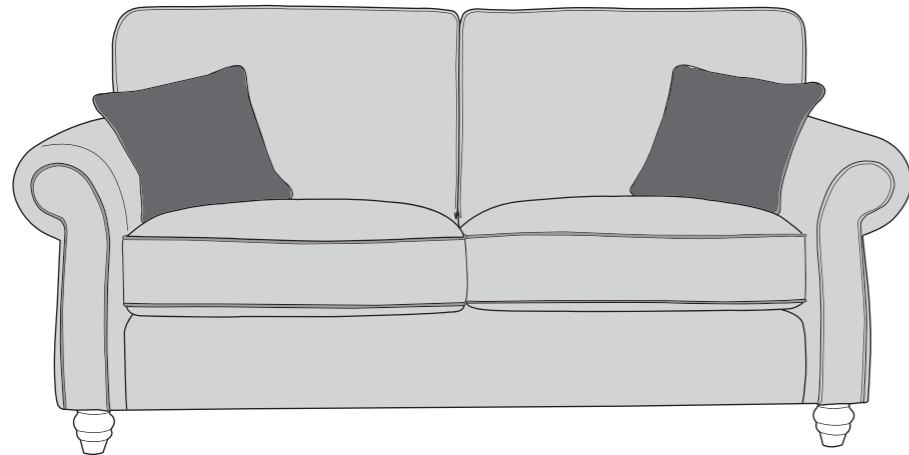

3 Seater Sofa (3ST)

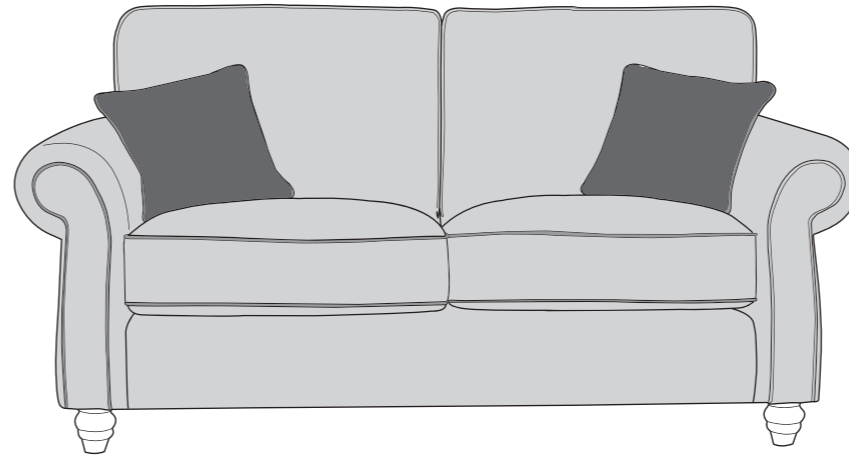

2 Seater Sofa (2ST)

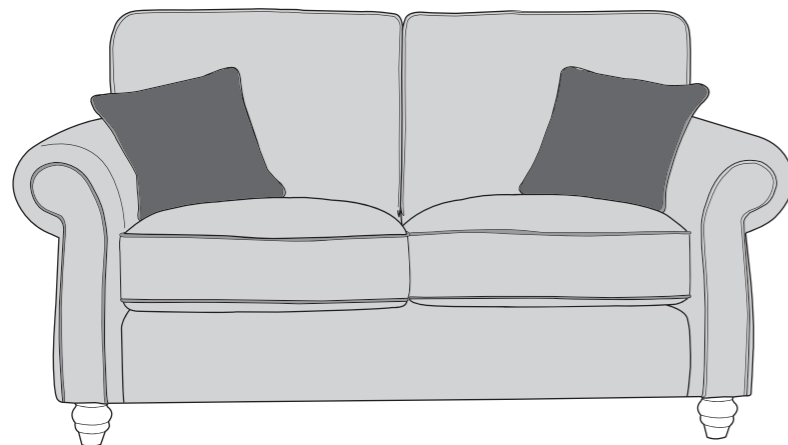

Arm Chair (1ST)

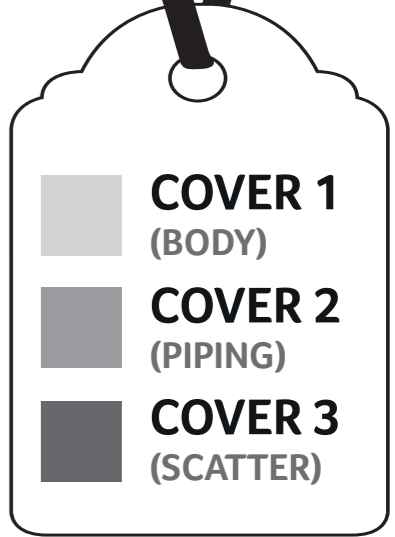
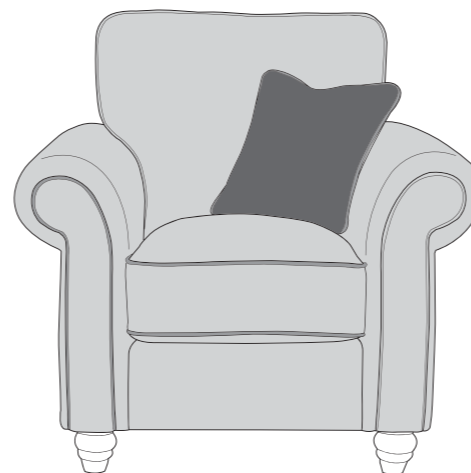

COVER 1
(BODY)

COVER 2
(PIPING)

COVER 3
(SCATTER)

Scatter Cushions

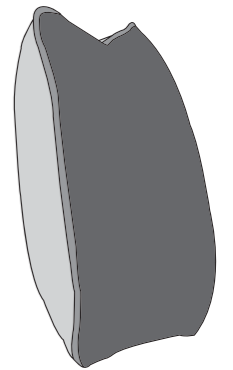

Front = Cover 3
Piping = Cover 2
Back = Cover 1

ACCENT PIECES

Finley Wing Chair (ACH)

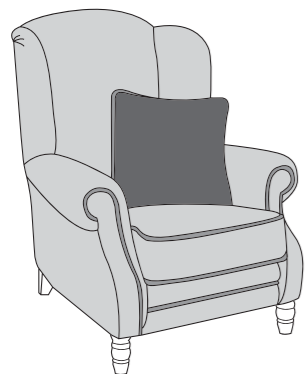

Finley Footstool (FST)

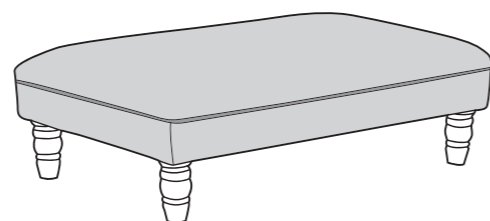

Storage Footstool F (FSS)

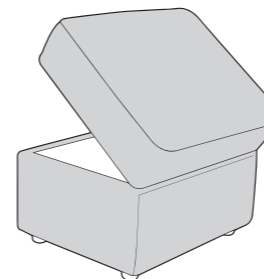

FINLEY DIMENSIONS (CM)

AVAILABLE PIECES	HEIGHT 1	WIDTH 2	DEPTH 3	SEAT HEIGHT 4	SEAT DEPTH 5	SEAT WIDTH 6	ACCESS DIAGONAL 7	WEIGHT (KG)	SCATTER CUSHIONS
4 SEATER SOFA (4ST)	96	201	96	54	54	148	N/A	60	2
3 SEATER SOFA (3ST)	96	181	96	54	54	128	N/A	55	2
2 SEATER SOFA (2ST)	96	161	96	54	54	108	N/A	51	2
ARM CHAIR (1ST)	96	99	96	54	54	48	N/A	38	1
ACCENT PIECES									
FINLEY WING CHAIR (ACH)	105	84	86	45	55	46	107	33.5	1
FINLEY FOOTSTOOL (FST)	35	106	65	N/A	N/A	N/A	N/A	15.5	N/A
STORAGE FOOTSTOOL (FSS)	45	63	50	N/A	N/A	N/A	75	12.5	N/A

* Hardwood & composite board frame.

* Dowelled, screwed, glued & stapled joinery.

* Light & Dark Wood foot options.

* Award winning foamflex seat interior with 5 year guarantee.

* Reversible fibre filled backs for added comfort.

* Feather filled scatters included.



* Serpentine seat & silent wire.

* Superloop back springs.

DIMENSION GUIDE

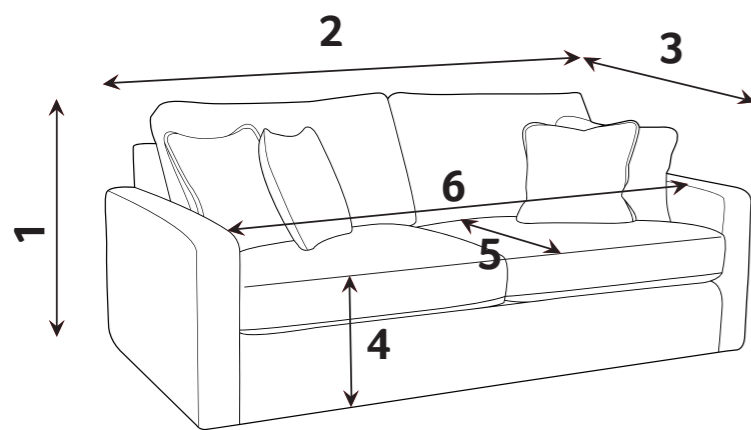

Check the diagonal access dimension to ensure furniture will fit in your home.

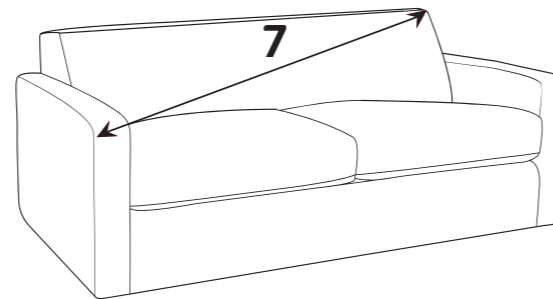

1 - HEIGHT
2 - WIDTH

3 - DEPTH
4 - SEAT HEIGHT

5 - SEAT DEPTH (STD & PILLOW)
6 - SEAT WIDTH

7 - DIAGONAL ACCESS

Illustrations used for reference only.

Please note : All dimensions are approximate. Allow tolerance of +/- 2.5cm.

foamflex™

Our new expertly engineered foam seat interior gives you the comfort of fibre with the retention of foam.

CARE GUIDE

To improve the longevity of your hand-made furniture, we recommend rotating cushions (where applicable).

For further information on maintaining your furniture, please refer to the Care Guide located under the seat platform.



Our foamflex seat interiors have been granted the FIRA GOLD Award, a mark of quality under-pinning all necessary testing of the product materials, design and production techniques.

Oak (light)



Antique (dark)



FOOT OPTIONS:

Wood is a natural product and will vary in shade/colour from item to item. Feet may require fitting.

