



Cover 2:  
Larry Latte

Cover 1:  
Leo Wicker

Cover 3:  
Angus Natural

Cover 4:  
Carson Marble

Brushed Brass Feet

# Axel Collection

Please note that colour shadings can vary slightly from each roll of fabric.  
We cannot guarantee a precise match to these samples or between cut lengths and upholstered goods.

**Extra Flex**<sup>®</sup>



# AXEL COVER GUIDE: STANDARD BACK

Please use this guide when ordering the following pieces to clarify cover options.

LH2, RCC Corner Group - LHC-S-C

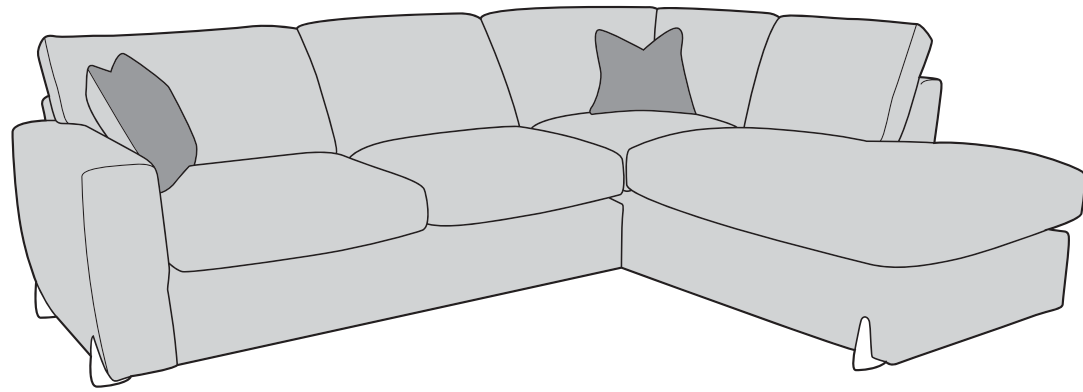

LCC, RH2 Corner Group - RHC-S-C

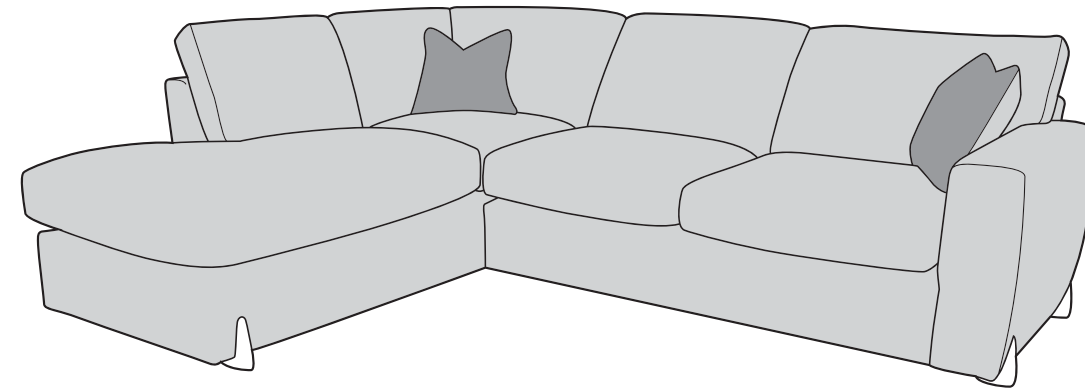

3 Seater Sofa - 3ST-S-C

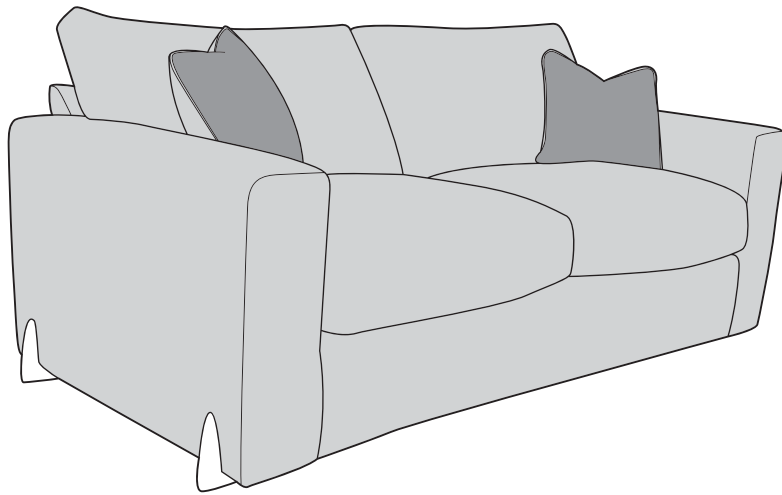

2 Seater Sofa - 2ST-S-C

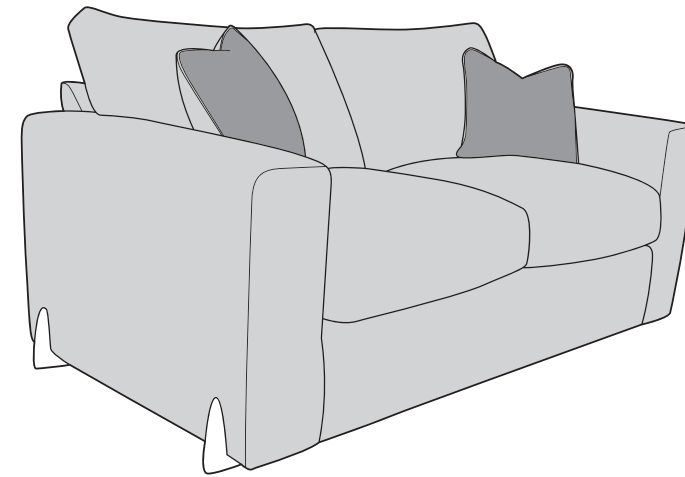

Love Chair - LOV-S-C

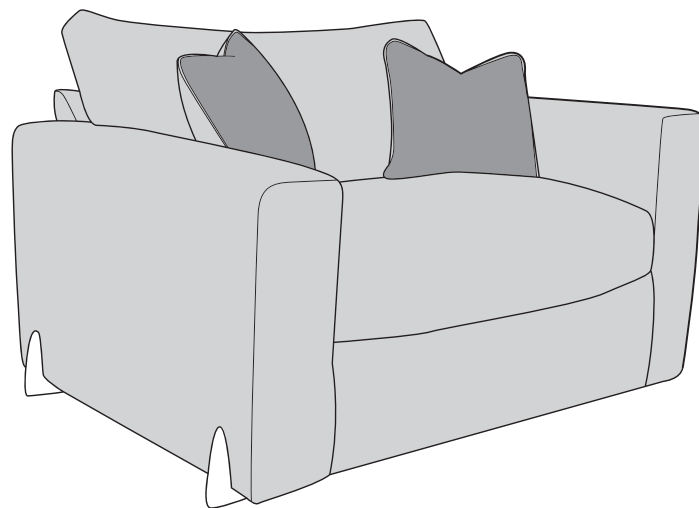

Arm Chair - 1ST-S-C

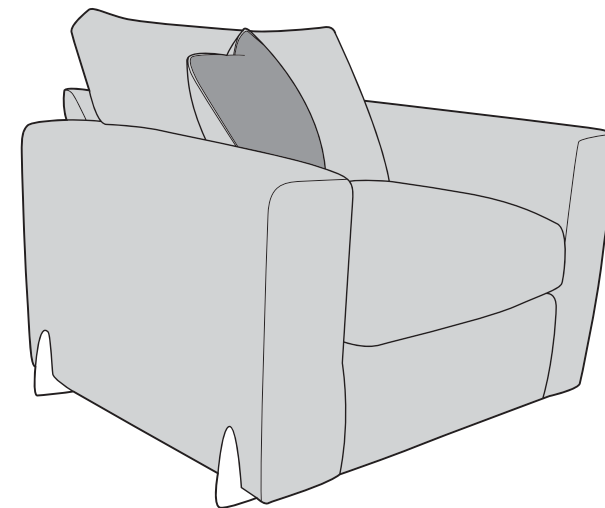

 **COVER 1**  
(BODY)

 **COVER 2**  
(SCATTER)

Scatter Cushions

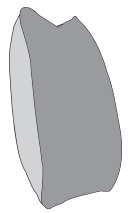

Front = Cover 2  
Back = Cover 1

 **BFM**  
BRITISH FURNITURE  
MANUFACTURERS  
APPROVED MEMBER

 **A©ID**  
ANTI COPYING IN DESIGN

# AXEL COVER GUIDE: PILLOW BACK

Please use this guide when ordering the following pieces to clarify cover options.

LH2, RCC Corner Group - LHC-P-C

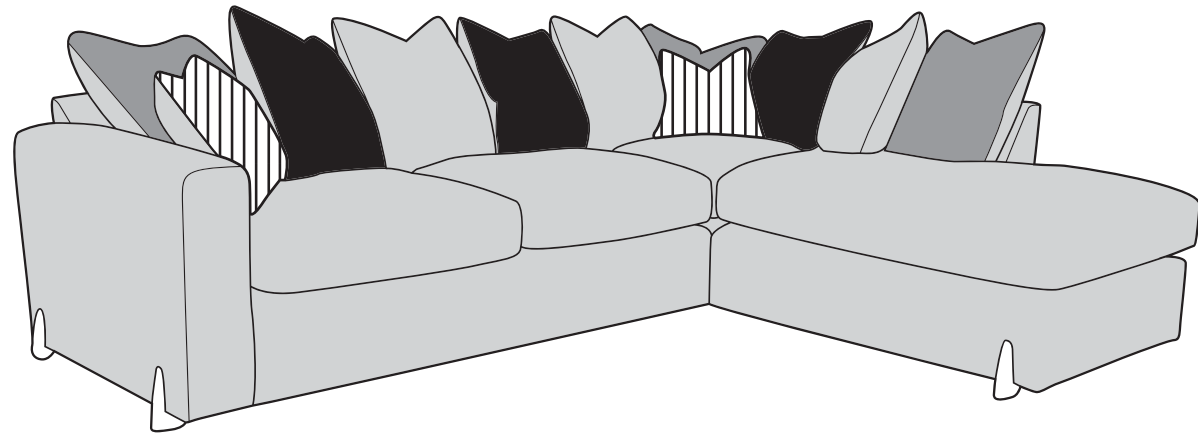

LCC, RH2 Corner Group - RHC-P-C

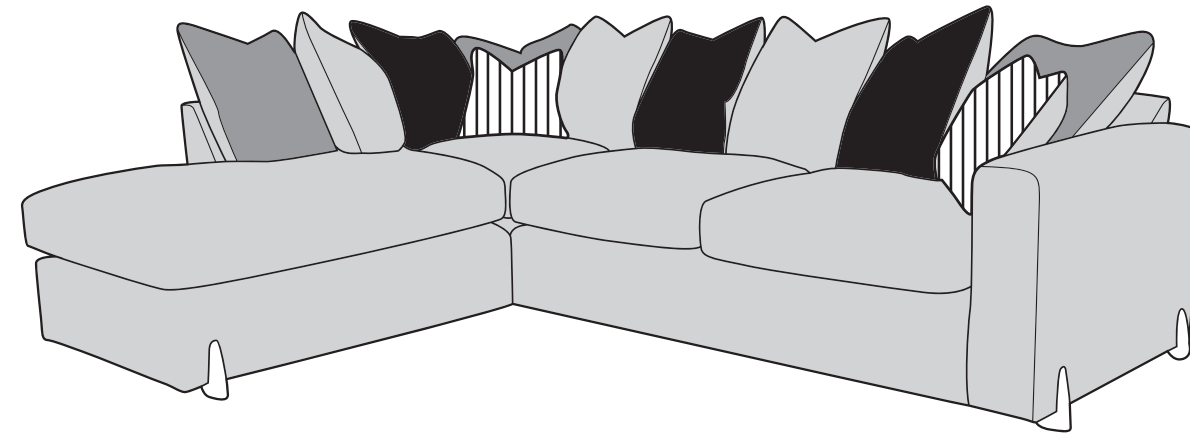

3 Seater Sofa - 3ST-P-C

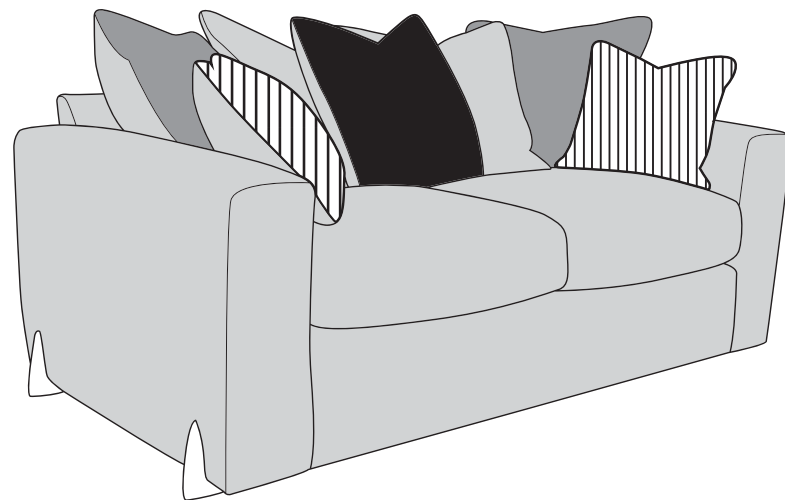

2 Seater Sofa - 2ST-P-C

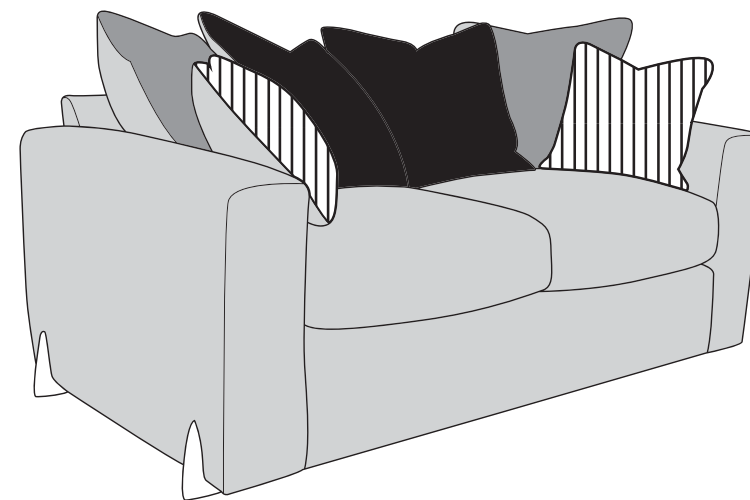

Love Chair - LOV-P-C

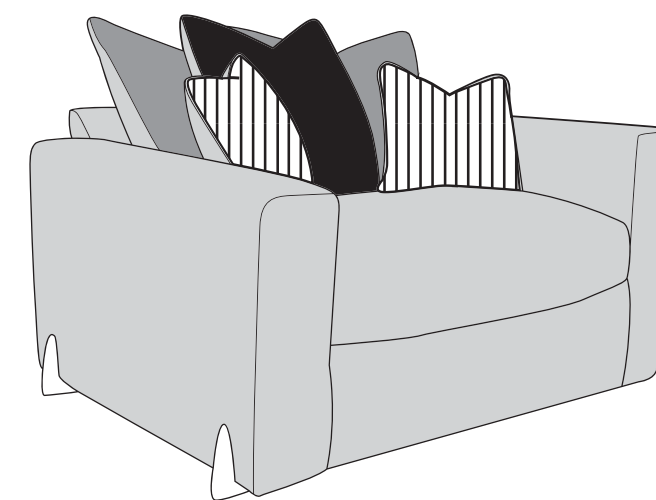

-  **COVER 1**  
(BODY)
-  **COVER 2**  
(PILLOW)
-  **COVER 3**  
(PILLOW)
-  **COVER 4**  
(SCATTER)

## Scatter Cushions

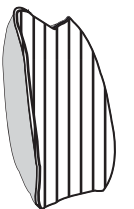

Front = Cover 4  
Back = Cover 1

## SUGGESTED ACCENT PIECES

Axel Footstool (FST)

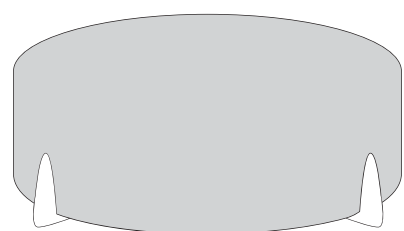

# AXEL DIMENSIONS (CM)

AVAILABLE PIECES	HEIGHT 1	WIDTH 2	DEPTH 3	SEAT HEIGHT 4	SEAT DEPTH 5	SEAT WIDTH 6	ACCESS DIAGONAL 7	OUTBACK HEIGHT 8	ARM HEIGHT 9	WEIGHT (KG)	SCATTER CUSHIONS
CORNER GROUP: LH2, RCC or LCC, RH2	93	284	217	54	N/A	N/A	N/A	72	66	123	2
LH2/RH2 UNIT	93	187	97	54	56	163	205	72	66	57	1
LCC/RCC UNIT	93	217	97	54	56	N/A	232	72	N/A	66	1
3 SEATER SOFA (3ST)	93	205	97	54	56	157	219	72	66	67.5	2
2 SEATER SOFA (2ST)	93	180	97	54	56	129	197	72	66	62	2
LOVE CHAIR (LOV)	93	131	97	54	56	85	163	72	66	54	2
ARMCHAIR (1ST)	93	101	97	54	56	55	140	72	66	46.5	1
<b>ACCENT PIECES</b>											
AXEL FOOTSTOOL (FST)	37	107	107	N/A	N/A	N/A	N/A	N/A	N/A	23.5	N/A

\* Hardwood & composite board frame.

\* Dowelled, screwed, glued & stapled joinery.

\* Extraflex seat interior

\* Fibre filled standard backs for added comfort.

\* Sumptuous feather filled pillow backs. 

\* Feather filled scatters included. 

\* Serpentine seat springs & silent wire.

\* Elasticated back webbing.

## DIMENSION GUIDE

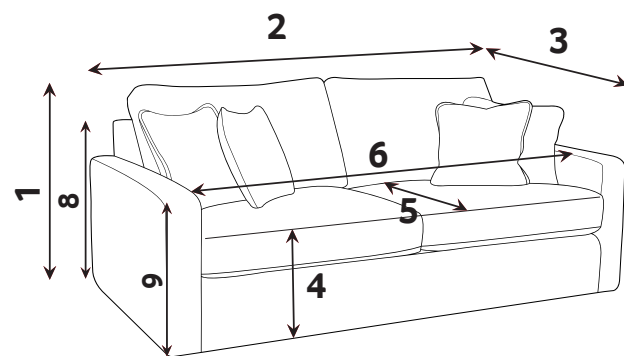

Check the diagonal access dimension to ensure furniture will fit in your home.

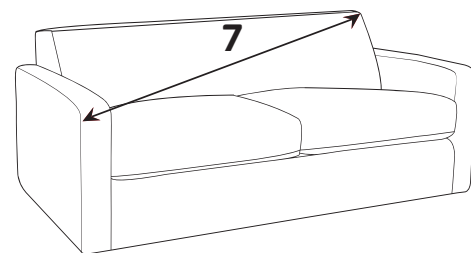

- 1 - HEIGHT
- 2 - WIDTH
- 3 - DEPTH
- 4 - SEAT HEIGHT
- 5 - SEAT DEPTH (STD & PILLOW)
- 6 - SEAT WIDTH
- 7 - DIAGONAL ACCESS
- 8 - OUTBACK HEIGHT
- 9 - ARM HEIGHT

Illustrations used for reference only.

## Extra Flex<sup>®</sup>

A high density foam base seat interior with a hand-rolled carded fibre, channelled topper which provides both softness and support.

### CARE GUIDE

Extraflex seat cushions should be **plumped up on a regular basis** to help maintain the aesthetical appeal of your upholstery, the plumping of cushions is essential to help retain the comfort and softness of any piece of upholstered furniture.

To improve the longevity of your hand-made furniture, we recommend rotating cushions (where applicable). For further information on maintaining your furniture please refer to the care guide located under the seat platform.

Brushed Steel

Brushed Brass

Walnut

Mid Oak



FOOT OPTIONS:

